

TraceTek TT-NRM

NETWORK RELAY MODULE INSTALLATION INSTRUCTIONS

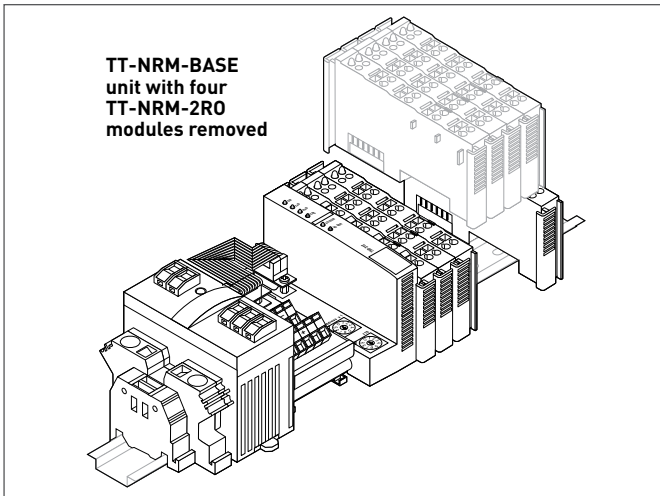

DESCRIPTION

The TraceTek Network Relay Module provides multiple relay outputs for switching alarm or control devices for the leak detection system. TT-NRM units are modular and may be configured with 2 to 32 relay outputs. A single TTDM-128 unit communicates with up to up to 20 NRMs over a single, twisted pair RS-485 cable.

ADDITIONAL MATERIALS REQUIRED

- TT-NRM-2RO, 2-channel relay output module (marked 750-517) [up to 15 additional modules may be added to one TT-NRM-BASE]
- RS-485 cable, 1 shielded twisted pair [TT-RS485-BULK or equivalent]
- Suitable enclosure or panel
- Additional wire, as necessary

TOOLS REQUIRED

- 3.5-mm flat-blade terminal screwdriver
- Wire stripper/cutter

REFERENCE DOCUMENTS

- TTDM-128 Installation Manual (H57341)
- TTDM-128 User Manual (H56583)

SPECIFICATIONS

Function	Provides relay outputs to switch power to contactors under control of the TTDM-128
Ambient operating range	0°C to 55°C (32°F to 130°F)
Ambient storage range	-40°C to 60°C (-40°F to 140°F)
Relative humidity	5% to 95%, noncondensing
Supply voltage	94-264 Vac
Supply current	60 VA max.
Relay output type	Mechanical, normally open, voltage free
Relay output rating	230 Vac, 30 Vdc, 2 A max.
Communications	RS-485, single shielded twisted pair, max. 20 NRM units per network
Connection terminals	28-12 AWG (0.08-2.5 mm ²)

APPROVALS



KIT CONTENTS

TT-NRM-BASE:

1	Network processor (marked 750-315)
1	24 Vdc power supply (marked 5101-7663)
1	Relay output module (marked 750-517)
1	End termination module (marked 750-600)
1	RS-485 network connection module
1	Ribbon cable with screws
1	DIN 35 rail for mounting
1	Ground terminal
2	DIN rail end stops

WARNING:

This component is an electrical device. It must be installed correctly to ensure proper operation and to prevent shock or fire. Read and carefully follow these important installation instructions.

TT-NRM System Layout

- The TTDM-128 controls up to 127 circuits of leak detection. TT-NRM units switch external alarm or control devices. NRMs are connected to the TTDM-128 unit via a single RS-485 network.

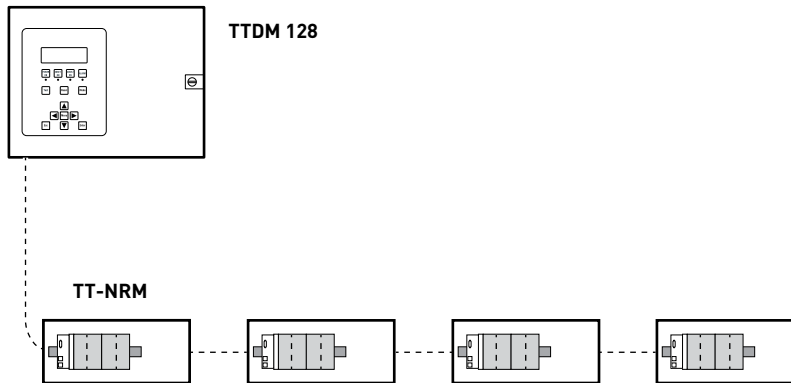

TT-NRM Assembly

- 1 Network processor (marked 750-315)
- 2 2-channel relay output module(s) (marked 750-517) [up to 16 total modules allowed per processor]
- 3 End termination module (marked 750-600)
- 4 DIN 35 rail
- 5 Address switches
- 6 RS-485 ribbon cable
- 7 RS-485 network connection module
- 8 24 Vdc power supply
- 9 Ground terminal
- 10 End stops

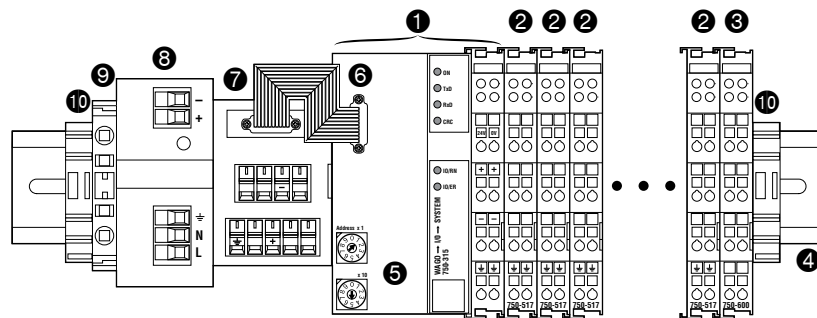

Overview of installation procedures for TT-NRM

- A. Mount TT-NRM assembly in enclosure selected for the application.
- B. Connect power and relay contact wiring.
- C. Connect RS-485 cables and set address.
- D. Update the TTDM-128 network.

A. Mount DIN rail

1. Select a location for installation.

The TT-NRM may be installed in any panel or enclosure suitable for electronic control devices.

The TT-NRM assembly is powered with line voltage and switches relay contacts that may be connected to line voltage. Select an electrical panel or enclosure considering the area classification (i.e., non-hazardous or hazardous), the location (indoors or outdoors, exposure to moisture and/or dust), and the chemical environment.

If ambient temperatures below freezing are expected, install the TT-NRM unit in a heated location or use an enclosure heater. If moisture is expected, install a drain in the enclosure.

2. Size and install DIN rail.

Use the supplied DIN 35 rail. The rail may be shortened if necessary. The width of the TT-NRM assembly is determined based on the number of TT-NRM-2R0 relay modules used.

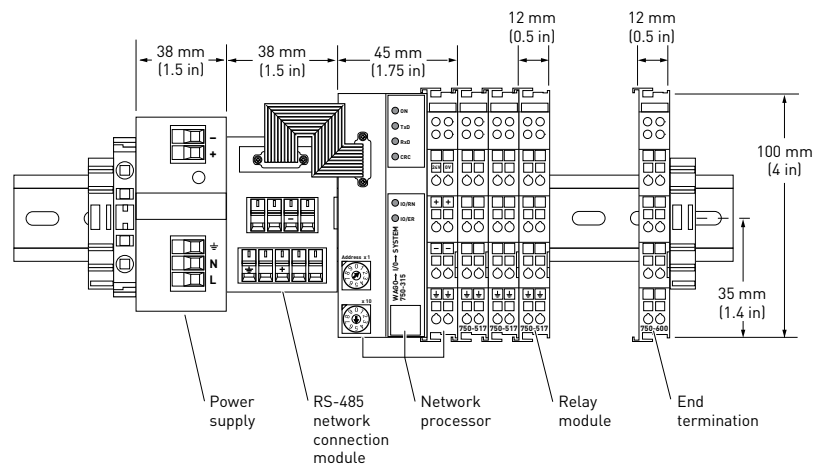

$$\begin{aligned} \text{Overall width} &= 157 \text{ mm} + 12 \text{ mm per relay module} \\ &= 6.25 \text{ in} + 0.5 \text{ in per relay module} \end{aligned}$$

B. Install TT-NRM assembly

1. Attach the TT-NRM components to the DIN rail

The TT-NRM-BASE comes assembled. To remove a module, pull up on the orange release tab until the module releases from the DIN rail. **Do not remove modules while power is on.**

To install additional TT-NRM-2RO relay modules, **you must first remove the End termination module (3)** and the adjacent DIN rail end stop. Slide the additional relay modules into place and ensure they snap on to the DIN rail. Replace the End termination module and DIN rail end stop to the right of the last relay module added.

Refer to the TT-NRM Assembly diagram on page 2 for the proper order of module assembly.

Important: Modules and/or external equipment may be damaged if modules are not installed in the correct sequence.

2. Attach the RS-485 network connection module to the DIN rail.

Locate the module to the left side of the Network processor. Press the module down onto the DIN rail to lock it in place.

Connect the supplied ribbon cable between the Network processor and the RS-485 connection module.

Use the screws provided to secure the ribbon cable connectors.

3. Mount the power supply.

Mount the power supply on the DIN rail to the left of the RS-485 network connection module.

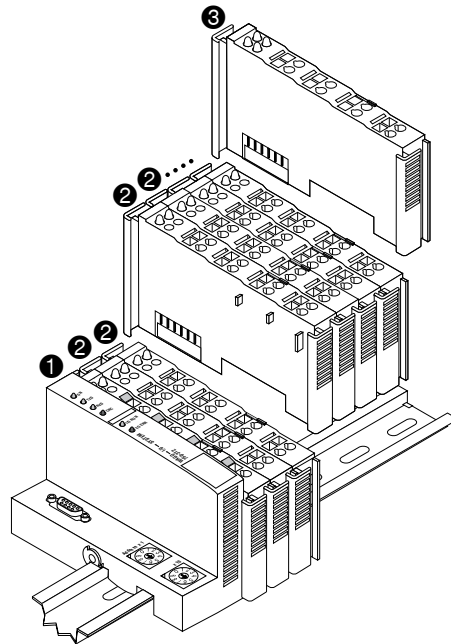
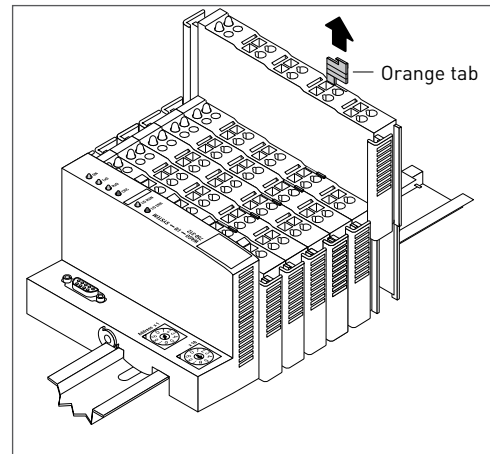

C. Connect power wiring

Note: TT-NRM units use WAGO® cage-clamp spring terminals for secure wire connections. Review the steps at right for using this type of terminal.

Note: Strip length for wires in WAGO terminals is 10 mm (3/8 in).

Using WAGO Terminals

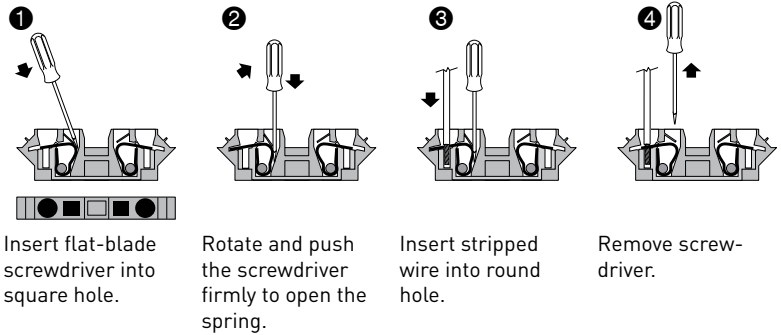

1. Connect 24 Vdc wiring.

24 Vdc supply must be connected to the Network processor module. Connect wires from the power supply output to the terminals shown.

Connection terminals on TT-NRM module accept 28–12 AWG (0.08–2.5 mm²) wire.

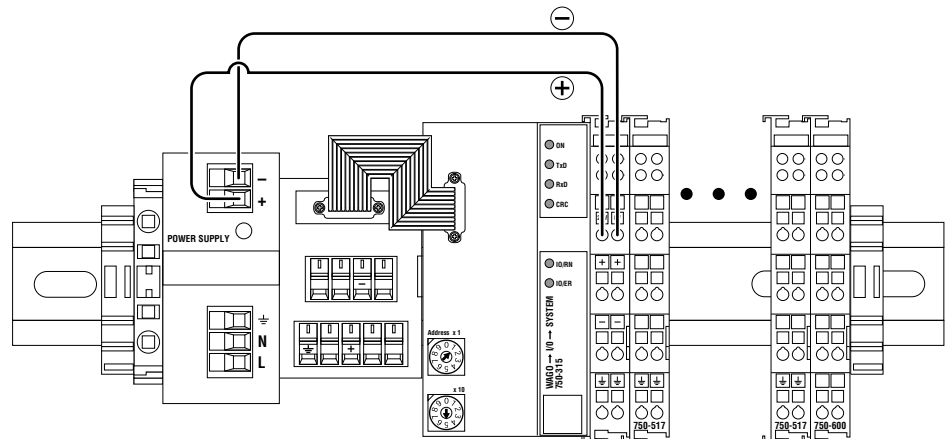

2. Connect line voltage supply.

Connect line voltage and ground to the input of the power supply as shown.

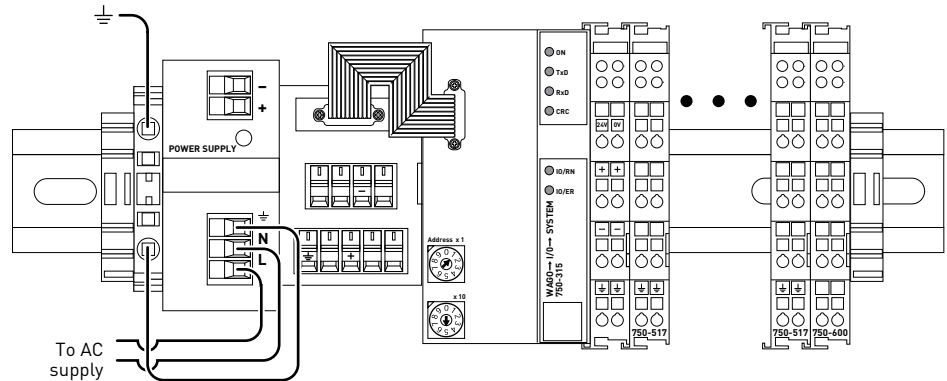

Note: Previous wiring omitted for clarity

3. Connect wiring to relay contacts.

Connect the external alarm or control devices to the terminals on each TT-NRM-2RO 2-channel relay output modules as shown.

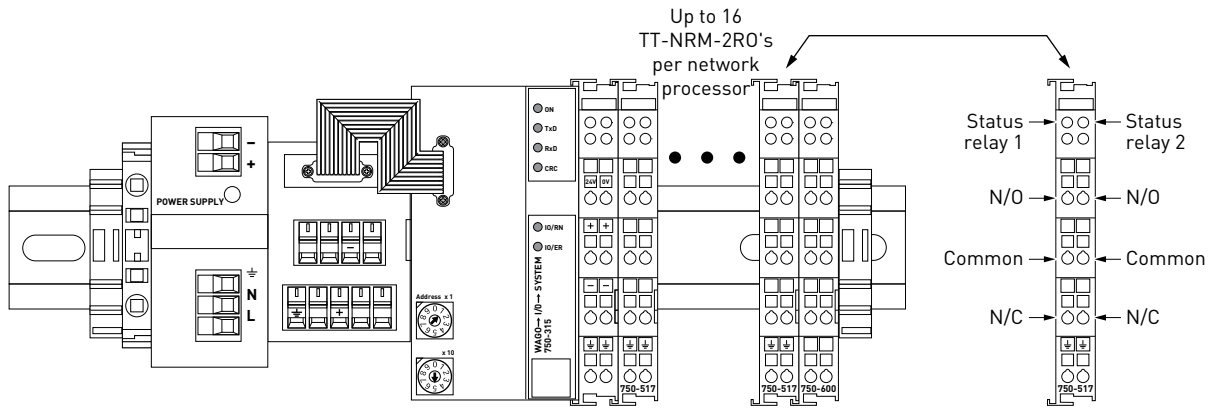

Note: Previous wiring omitted for clarity

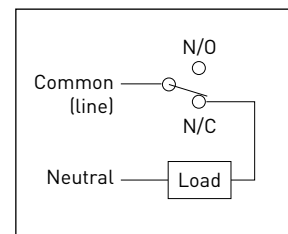

D. Connect RS-485 cables and set address

1. Select the RS-485 address for the TT-NRM unit.

Each TT-NRM connected to a TTDM-128 must have a unique address in the range 1 to 99. If two TT-NRM units are assigned the same address, communications faults will result.

To ensure you assign a unique address to each TT-NRM unit, review the system layout. If a layout document does not exist, create one. Assign a unique address to each TT-NRM unit.

2. Set the RS-485 address for the TT-NRM unit.

Use a small flat-blade screwdriver to rotate the address switch marked "x1" to the desired address. For an address of 50, set the "x1" to 0 and the "x10" to 5.

3. Connect RS-485 cables.

Note: Do not make connections to the RS-485 bus while it is connected to an operating TTDM-128, or damage and/or alarms could result.

The RS-485 bus allows units with unique addresses to be daisy-chained together along a common bus. To add a new unit to the network, simply daisy-chain the RS-485 bus from the last unit to the new one—or insert the new unit between two existing units on the bus. The order in which units are attached to the RS-485 bus does not matter. There are just two constraints on the RS-485 network:

- Each TT-NRM must be assigned a unique address.
- The RS-485 bus must be a continuous string from the first unit to the last unit in the system.

Note: The RS-485 bus operates at 5 V, and equipment connected to it could be damaged by exposure to higher voltages. Take precautions to avoid exposing the RS-485 wiring to discharge of static electricity or other sources of high voltage potential; in particular, avoid contact with the power supply wiring.

Note: TraceTek TTSIM modules are connected on the same RS-485 network and must not have the same address as any TT-NRM.

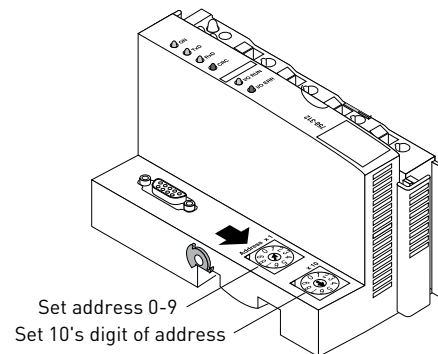

- 1 Connect the clear or white wire of the RS-485 cable to the (+) terminal as shown.
- 2 Connect the black wire of the RS-485 cable to the (-) terminal as shown.
- 3 Connect the shield wire of the RS-485 cable to the shield terminal as shown.

If connecting two RS-485 cables (one IN and one OUT), use the same terminals for both wires.

Important: Do not connect the shield of the RS-485 cable to the enclosure or panel grounding terminal. Connect the shield only to the terminal provided. To avoid the potential for spurious ground loops, the RS-485 cable shield should be connected to ground only in the TTDM-128.

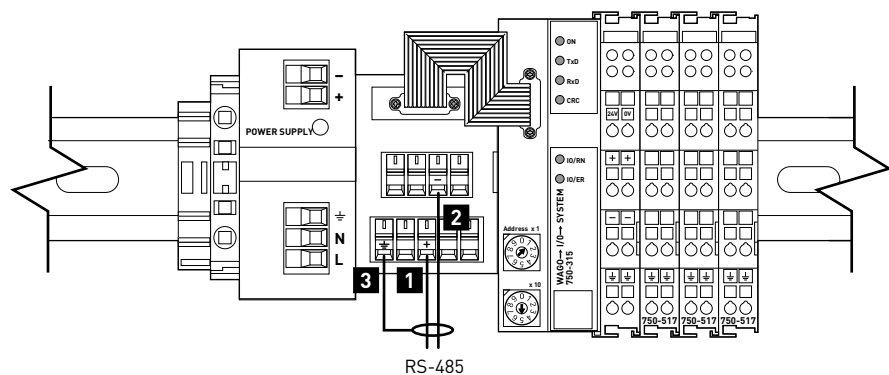

Note: Previous wiring omitted for clarity

E. Update the TTDM-128 Network

TT-NRM units are controlled by a central TTDM-128. The Update Network Function in the TTDM-128 software must be triggered in order for the TTDM-128 to recognize new or changed TT-NRM units. Until this software function is run, the TTDM-128 will not control new TT-NRM units.

1. Energize all TT-NRMs in the network.

Confirm that the RS-485 network is complete (all TT-NRM and TTSIM units and the TTDM-128 are connected to the RS-485 bus), and that the power to each unit has been turned on.

2. Use the TTDM-128 system software to update the network.

Note: When the TTDM-128 is first powered, it automatically runs the "Update" function.

Run the TTDM-128 "Update Network" software function to trigger it to recognize new TT-NRMs. The TTDM-128 User Manual (H56853) describes this software function in detail.

3. If necessary due to problems or questions, check function of individual modules.

- Verify that a TT-NRM is functioning by confirming that the power LED is illuminated.
- Check all connections.
- Check that all TT-NRM modules are securely seated on the DIN rail.
- Confirm that the TT-NRM network does not have any duplicate RS-485 addresses.
- Individual relays can be checked using TTDM Self-test/NRM Relay test.

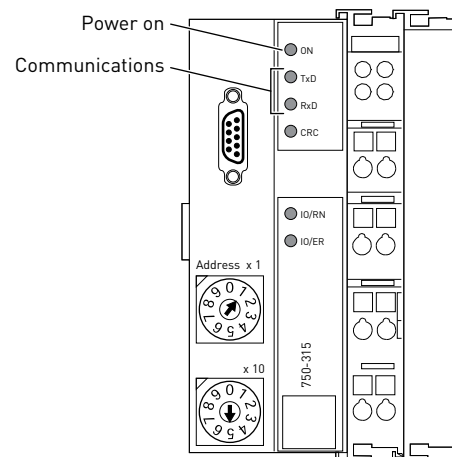

WWW.THERMAL.PENTAIR.COM

NORTH AMERICA

Tel: +1.800.545.6258
Fax: +1.800.527.5703
Tel: +1.650.216.1526
Fax: +1.650.474.7215
thermal.info@pentair.com

EUROPE, MIDDLE EAST, AFRICA

Tel: +32.16.213.511
Fax: +32.16.213.603
thermal.info@pentair.com

ASIA PACIFIC

Tel: +86.21.2412.1688
Fax: +86.21.5426.2917
cn.thermal.info@pentair.com

LATIN AMERICA

Tel: +55.11.2588.1400
Fax: +55.11.2588.1410
thermal.info@pentair.com

Pentair and TraceTek are owned by Pentair or its global affiliates. All other trademarks are the property of their respective owners. Pentair reserves the right to change specifications without prior notice.