

## Multipoint heat-trace controller

### Product overview

The DigiTrace® 920 is a compact, full-featured, microprocessor-based, multipoint heat-trace controller. The 920 provides control and monitoring of two independent electrical heat-tracing circuits for both freeze protection and temperature maintenance, and can be set to monitor and alarm for high and low temperature, high and low current, ground-fault level, and voltage on each of its control points. The DigiTrace 920 controller is available with two output types: an electromechanical relay (EMR) for use in nonhazardous areas and a solid-state relay (SSR) for use in nonhazardous and Class I Div. 2/Zone 2 hazardous areas. Communications modules are available for remote control and configuration, complete with supervisor software capability.

### Control

The DigiTrace 920 measures temperatures with 3-wire 100-ohm platinum RTDs connected directly to the unit. Up to two RTDs are supported for each of the two control points. The controller may be used in line-sensing, ambient-sensing, proportional ambient-sensing, and power-limiting modes.

### Monitoring

A variety of parameters are measured, including ground fault, temperature, and current to ensure system integrity. The system can be set to periodically check the heating cable for faults, alerting maintenance personnel of a heat-tracing problem.

A dry contact relay is provided for alarm annunciation back to a distributed control system (DCS).

### Ground-fault protection

National electrical codes require ground-fault equipment protection on all heat-tracing circuits. Heat-tracing circuits equipped with DigiTrace 920 controllers do not require additional ground-fault detection equipment, simplifying installation and reducing costs.

### Installation

The standard DigiTrace 920 unit comes ready to install right from the box, eliminating the need for custom panel design or field assembly. Custom configurations are also available from the factory to allow the user to tailor the solution to the application. The NEMA 4X-rated FRP or optional stainless steel enclosures are approved for use in

indoor and outdoor locations. Wiring is as simple as connecting the incoming and outgoing power wiring (up to 600 Vac) and an RTD.

The DigiTrace 920 operator console includes LED displays and function keys that make it easy to use and program. No additional handheld programming devices are needed. Alarm conditions and programming settings are easy to interpret on the full-text front panel. Settings are stored in nonvolatile memory in the event of power failure.



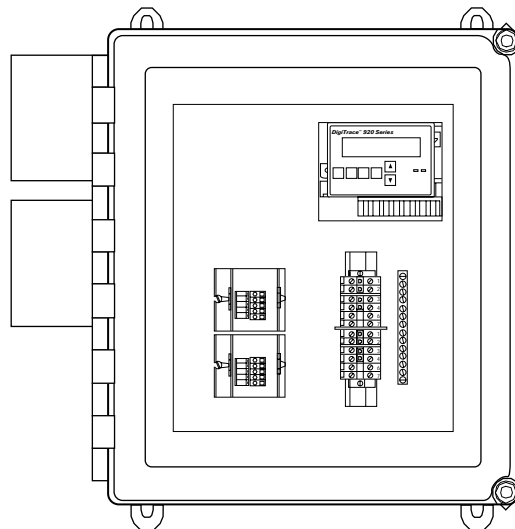

### Communications

DigiTrace 920 units may be networked to a host PC running Windows™-based DigiTrace Supervisor software for central programming, status review, and alarm annunciation. DigiTrace 920 units support the Modbus™ protocol and may be ordered with an RS-485 communications interface.

920\*E4FWL\*SIS302\*SS3102 shown

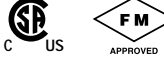

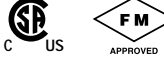
**General**

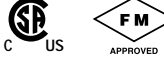
Area of use	Nonhazardous locations (EMR versions) Nonhazardous and Division 2 hazardous locations (SSR versions)		
Approvals	<table border="0"> <tr> <td style="text-align: center;"> <b>Nonhazardous locations</b> (SSR and EMR versions)   </td> <td style="text-align: center;"> <b>Hazardous locations</b> (SSR versions only)                        Class I, Div. 2, Groups A, B, C, D                      Ex nA IIA, IIB, IIC                      T-code: T4 (T3A with optional alarm light)                 </td> </tr> </table>	<b>Nonhazardous locations</b> (SSR and EMR versions) 	<b>Hazardous locations</b> (SSR versions only)  Class I, Div. 2, Groups A, B, C, D Ex nA IIA, IIB, IIC T-code: T4 (T3A with optional alarm light)
<b>Nonhazardous locations</b> (SSR and EMR versions) 	<b>Hazardous locations</b> (SSR versions only)  Class I, Div. 2, Groups A, B, C, D Ex nA IIA, IIB, IIC T-code: T4 (T3A with optional alarm light)		
Supply voltage	<ul style="list-style-type: none"> <li>• 100 Vac to 277 Vac, +5%/-10%, 50/60 Hz Common supply for controller and heat-tracing circuit</li> <li>• Up to 600 Vac for heat-tracing circuit when controller is powered from a separate circuit</li> </ul>		

**Enclosure**

Protection	NEMA 4X
Materials	FRP or optional stainless steel
Ambient operating temperature range	-40°F to 140°F (-40°C to 60°C)
Ambient storage temperature range	-40°F to 185°F (-40°C to 85°C)
Relative humidity	0% to 90%, noncondensing

**Control**

Relay types	3-pole, mechanical (EMR versions) 1-, 2-, or 3-pole solid-state, normally open (SSR versions)
Voltage, maximum	277 Vac nominal, 50/60 Hz (standard), 600 Vac nominal (optional)
Current, maximum	30 A @ 40°C (standard) <i>For ratings at higher ambient temperatures, contact the factory.</i> 60 A @ 40°C (optional)
Control algorithms	EMR: Line sensing on/off, proportional ambient SSR: Line sensing on/off, proportional, proportional ambient, power limiting, soft start
Control range	-76°F to 1058°F (-60°C to 570°C)

**Typical Enclosure Dimensions**

920\*E4FWL\*SIS302\*SS3102 (1 pole model) shown  
920\*E4FWL\*SIS302\*SS3202 (2 pole model)

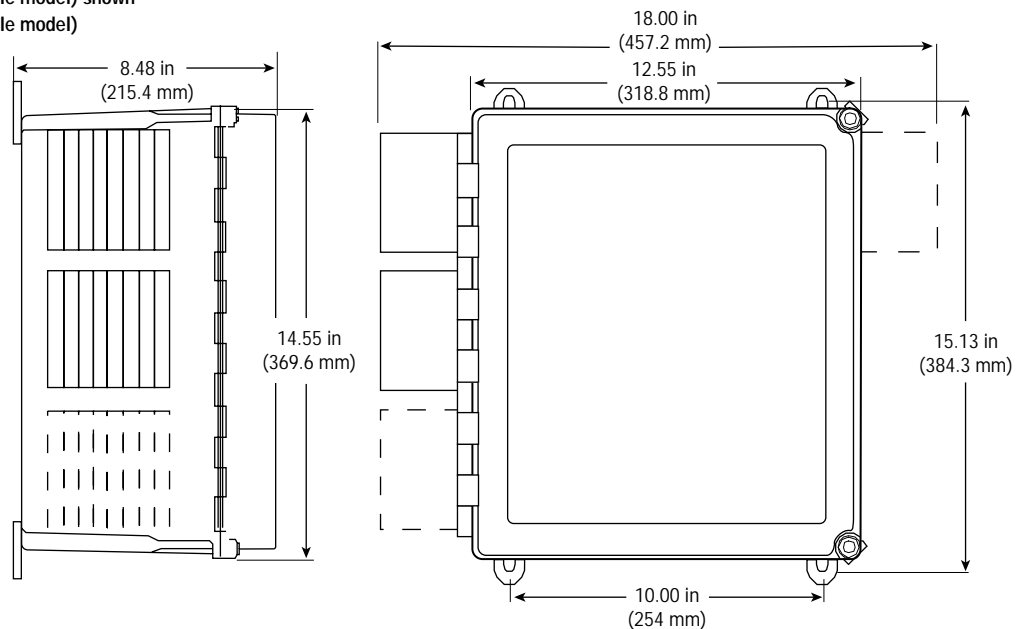

**Monitoring (each control point)**

Temperature	Low alarm range	-76°F to 1058°F (-60°C to 570°C) or OFF
	High alarm range	-76°F to 1058°F (-60°C to 570°C) or OFF
Ground fault	Alarm range	20 mA to 250 mA or OFF
	Trip range	20 mA to 250 mA or OFF
Current	Low alarm range	0.3 Amps to 100 Amps or OFF
	High alarm range	0.3 Amps to 100 Amps or OFF
	Power limit	3 W to 33 kW
Voltage	Low alarm range	10 V to 330 V or OFF
	High alarm range	10 V to 330 V or OFF
Resistance	Low resistance range	1% to 100% of deviation from nominal
	High resistance range	1% to 250% of deviation from nominal
Autocycle	Diagnostic test interval adjustable from 1 to 240 minutes or 1 to 240 hours	

**Temperature Sensor Inputs (each control point)**

Quantity	Two inputs standard
Types	100 $\Omega$ platinum RTD, 3-wire, $\alpha = 0.00385$ ohms/ohm/°C Can be extended with a 3-conductor shielded cable of 20 $\Omega$ maximum per conductor 100 $\Omega$ Ni-Fe RTD, 2-wire

**Alarm Outputs**

Dry contact relay	Pilot duty only, 48 Vac/dc, 500 mA maximum, 10 VA maximum resistive switching
<b>Note:</b> Output is configurable as "open on alarm" or "close on alarm"	

**Programming and Setting**

Method	Programmable keypad or communications
Units	°F or °C
Digital display (using optional operator console)	Actual temperature, control temperature, heater current, voltage, resistance, ground fault, programming parameter values, alarm values
LEDs	Power on, heater(s) on, alarm conditions, receive/transmit data (standard) Current mode, heater(s) on, alarm conditions, receive/transmit data (using optional operator console)
Memory	Nonvolatile, restored after power loss, checksum data checking
Stored parameters (measured)	Minimum and maximum process temperature, maximum ground-fault current, maximum heater current, power accumulator, contactor cycle count, time in use
Alarm conditions	Low/high temperature, low/high current, low/high voltage, low/high resistance Ground-fault alarm, trip RTD failure, loss of programmed values, or EMR or SSR failure
Other	Multi-language support Password protection

**Connection Terminals**

Power supply input	Screw terminals, 22–8 AWG (30 A versions), 14–6 AWG (60 A versions)
Heating cable output	Screw terminals, 22–8 AWG (30 A versions), 14–6 AWG (60 A versions)
Ground	14–4 AWG ground bar
RTD/alarm/communications	28–12 AWG spring clamp terminals

**Mounting**

2 point FRP enclosure	Surface mounting with four fixing holes on 15.1 in x 10 in (384 mm x 254 mm) centers Hole diameter: 0.31 in (8 mm)
4 point FRP enclosure	Surface mounting with four fixing holes on 17.1 in x 12 in (435 mm x 305 mm) centers Hole diameter: 0.31 in (8 mm)
8 point FRP enclosure	Surface mounting with four fixing holes on 31.3 in x 21.9 in (795 mm x 556 mm) centers Hole diameter: 0.40 in (10 mm)
20 point FRP enclosure	Surface mounting with four fixing holes on 41.2 in x 30.2 in (1047 mm x 767 mm) centers Hole diameter: 0.40 in (10 mm)

**Communications (optional)**

Protocol	Modbus RTU or ASCII/HTCBus
Topology	Multidrop, daisy chain
Cable	Single shielded twisted pair, 26 AWG or larger
Length	1.7 miles (2.7 km) maximum @ 9600 baud
Quantity	Up to 32 devices without repeater
Address	Programmable

**Ordering Details****DigiTrace 920 Series Multipoint Heat-Trace Controller**

Description	Catalog number	Part number	Weight/lbs
<b>DigiTrace 920 controller–2 Pt</b> in a 14" x 12" x 8" FRP enclosure with window and quick-release latches, control module, and operator console. 1P 30 A 277 V SSR/pt. Controls two circuits, each with a 1-pole solid-state relay. (Approved for Class 1, Div. 2 areas)	920*E4FWL*SIS302*SS3102*HTC*CON	10160-010	27
<b>DigiTrace 920 controller–2 Pt</b> in a 14" x 12" x 8" FRP enclosure with window and quick-release latches, control module, and operator console. Includes an isolated 2-wire RS-485 communication option. 1P 30 A 277 V SSR/pt. Controls two circuits, each with a 1-pole solid-state relay. (Approved for Class 1, Div. 2 areas)	920*E4FWL*SIS302*SS3102*HTC485*CON	10160-011	27
<b>DigiTrace 920 controller–2 Pt</b> in a 14" x 12" x 8" FRP enclosure with window and quick-release latches, control module, and operator console. 2P 30 A 277 V SSR/pt. Controls two circuits, each with a 2-pole solid-state relay. (Approved for Class 1, Div. 2 areas)	920*E4FWL*SIS302*SS3202*HTC*CON	10160-012	32
<b>DigiTrace 920 controller–2 Pt</b> in a 14" x 12" x 8" FRP enclosure with window and quick-release latches, control module, and operator console. Includes an isolated 2-wire RS-485 communication option. 2P 30 A 277 V SSR/pt. Controls two circuits, each with a 2-pole solid-state relay. (Approved for Class 1, Div. 2, areas)	920*E4FWL*SIS302*SS3202*HTC485*CON	10160-013	32
<b>DigiTrace-Supervisory Software</b>	H57325		

---

**Ordering Details (Continued)**

---

**DigiTrace 920 Series Multipoint Heat-Trace Controller**

Must order from A, B, and C to complete the DigiTrace 920 system

Description	Catalog number	Part number	Weight/lbs
<b>A. ENCLOSURE ASSEMBLY—Need to add control module(s) and operator console(s) to complete controller</b>			
<b>DigiTrace 920 controller—4 Pt</b> in a 16" x 14" x 8" FRP enclosure with window and quick-release latches. 1P 30 A 277 V SSR/pt. Controls four circuits, each with a 1-pole solid-state relay. (Approved for use in Class 1, Div. 2 areas)	920*E6FWL*SIS304*SS3104	10160-125	30
<b>DigiTrace 920 controller—8 Pt</b> in a 30" x 24" x 12" FRP enclosure with window and 1/4 turn latch. 1P 30 A 277 V SSR/pt. Controls eight circuits, each with a 1-pole solid-state relay. (Approved for use in Class 1, Div. 2 areas)	920*E10FWQ1*SIS308*SS3108	10160-035	70
<b>DigiTrace 920 controller—20 Pt</b> in a 40" x 32" x 12" FRP enclosure with window and 1/4 turn latch. 1P 30 A 277 V SSR/pt. Controls 20 circuits, each with a 1-pole solid-state relay. (Approved for use in Class 1, Div. 2 areas)	920*E14FWQ1*SIS320*SS3120	10160-045	100
<b>Note:</b> Other enclosure sizes and types are available on special order. Contact the factory for additional details.			
<b>B. CONTROL MODULES—Requires one for every two control points</b>			
<b>DigiTrace 920 controller—Control module only</b> (No communications options installed)	920HTC	10260-001	1
<b>DigiTrace 920 controller—Control module with an isolated 2-wire RS-485 communication option installed</b>	920HTC*485	10260-004	1
<b>C. OPERATOR CONSOLE—Requires at least one per panel</b>			
<b>DigiTrace 920 controller—Operator console</b>	920CON	10260-005	1
<b>RTD Sensors</b>			
100-ohm platinum RTD with 10 foot stainless-steel corrugated sheath	RTD10CS	RTD10CS	1.0
RTD, ambient, cable style	RTD-200	254741	0.1
C1D1 RTD, -100°F to 900°F, pipe mounted	RTD7AL	RTD7AL	2.0
RTD, -100°F to 900°F, pipe mounted	RTD4AL	RTD4AL	1.2